

# Dr. Licht GmbH

Vorlaenderweg 9 51588 Nuembrecht Germany  
 Tele.: +49 2295 9035459 info@dr-licht.de



## full spectrum LED spegg © C300

380 nm      460 nm      540 nm      620 nm      700 nm      780 nm

### Features

- Zener diode is built in the protective circuit against static electricity
- Low Voltage DC Operated
- Long operating life
- Qualified according to JEDEC moisture sensitivity Level 2
- Compatible to IR reflow soldering



### Specifications (25°C)

Item	Symbol	Value	Unit
<b>Absolute Maximum Ratings</b>			
DC Forward Current	$I_F$	30	mA
Peak Pulse Forward Current *	$I_{FP}$	100	mA
Reverse Voltage	$V_R$	5	V
Power Dissipation	$P_D$	105	mW
Operating Temperature	$T_{OP}$	-40 ... +85	°C
Storage Temperature	$T_{STG}$	-40 ... +100	°C
Soldering Temperature (for 5 sec.)	$T_{SOL}$	260 ± 5	°C

\* Note: 1/10 duty cycle, 0.1 ms pulse width

Item	Symbol	Min.	Typ.	Max.	Unit
<b>Optical Specifications</b>					
CW Output Power	$P_O$	8.0	-	10.0	mW
Peak Wavelength * <sup>1</sup>	$\lambda_P$	380	-	800	nm
Viewing Angle	$\phi$	120			deg.
<b>Electrical Specifications</b>					
Forward Current	$I_F$	-	20	-	mA
Forward Voltage * <sup>2</sup>	$V_F$	3.2	-	4.2	V

\* Note:

1. Optical output measurement allowance is ± 10%
2. Forward voltage measurement allowance is ± 0.2 V

# Dr. Licht GmbH

Vorlaenderweg 9 51588 Nuembrecht Germany

Tele.: +49 2295 9035459

info@dr-licht.de

## Typical Performance Curves

### Relative Intensity vs. Forward Current

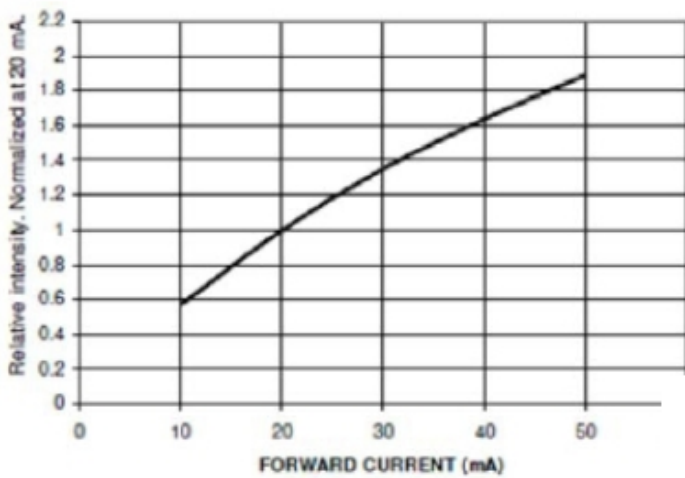

### Spectral Distribution

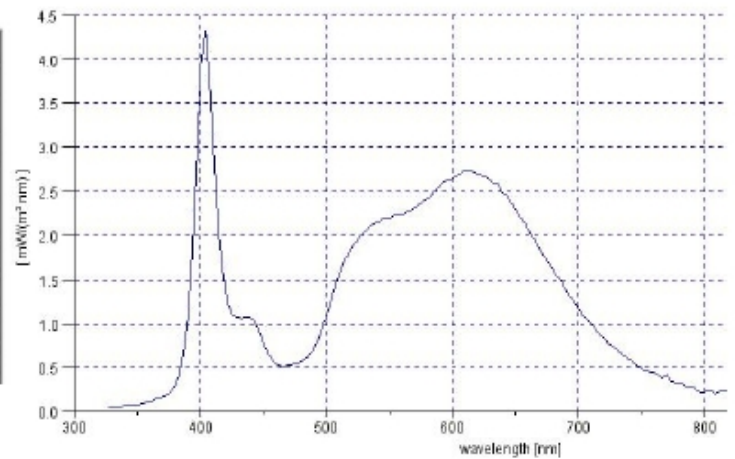

### Forward Voltage vs. Forward Current

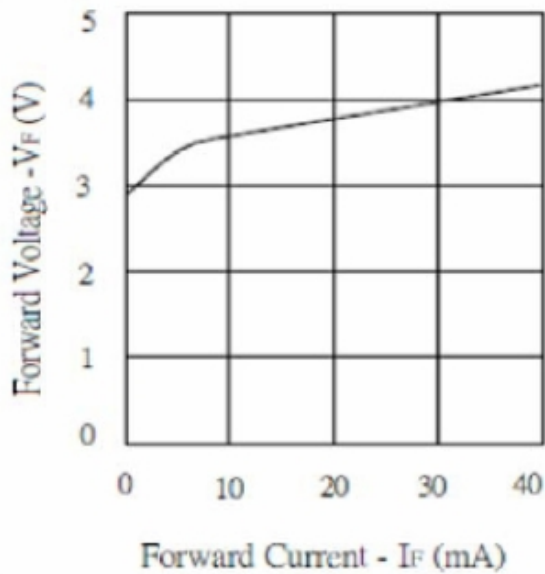

### Radiation Pattern

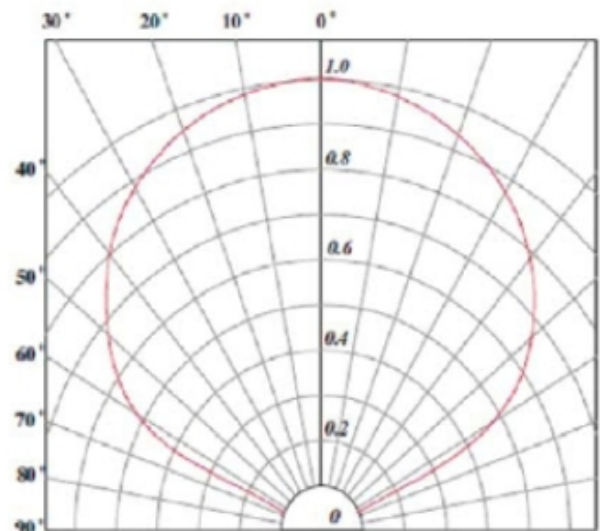

# Dr. Licht GmbH

Vorlaenderweg 9 51588 Nuembrecht Germany

Tele.: +49 2295 9035459

info@dr-licht.de

## Reliability

No.	Test Item	Standard Test Methode	Test Conditions	Note	Sample	Pass
1	Steady State operating Life	Internal Ref.	$I_f = 20 \text{ mA}$	168 Hr	20	OK
				500 Hr	20	OK
2	Soldering Test	JESD22-B102-C	230°C max	2 Times	60	OK
3	Reflow Test	JESD22-B102-C	230°C max	2 Times	20	OK
4	Thermal Shock	JESD22-A106-A	-40°C ... +85°C	84 Cycles	20	OK
5	Temperature Cycle	JESD22-A106-A	-35°C ... +75°C	168 Cycles	20	OK
6	High Temperature Storage	JESD22-A103-A	100°C	168 Hr	20	OK
7	Low Temperature Storage	Internal Ref.	-40°C	168 Hr	20	OK
8	High Temperature High Humidity	JESD22-A101-B	85°C, 85%RH	168 Hr	20	OK
9	On-Off Test	Internal Ref.	2sec ON - 2sec OFF	100000 cycle	20	OK

### Conclusions:

1. The reliability tests were designed to evaluate both package integrity as well as workability of product performance over time
2. All samples have done well by completed test required and passed all the qualification criteria with zero failure. From design standpoint, this package is robust enough to meet its datasheet conditions.
3. Based on the good result shows on the above test, this product is qualified and released for market.

## Precaution for Use

### 1. Cautions

- This device is a UV LED, which radiates UV light during operation.
- DO NOT look directly into the UV light or look through the optical system. To prevent in adequate exposure of UV radiation, wear UV protective glasses.

### 2. Static Electricity

- The LEDs are very sensitive to Static Electricity and surge voltage. So it is recommended that a wrist band or an anti-electrostatic glove be used when handling the LEDs.
- All devices, equipment and machinery must be grounded properly. It is recommended that precautions should be taken against surge voltage to the equipment that mounts the LEDs.

### 3. Heat Generation

- The powered LEDs generate heat. Heat dissipation should be considered in the application design to avoid the environmental conditions for operation in excess of the absolute maximum ratings.

# Dr. Licht GmbH

Vorlaenderweg 9 51588 Nuembrecht Germany

Tele.: +49 2295 9035459

info@dr-licht.de

## Surface Mount Condition

In automatic mounting of the SMD LEDs on printed circuit boards, any bending, expanding and pulling forces or shock against the SMD LEDs should be kept min. to prevent them from electrical failures and mechanical damages of the devices.

## Soldering Reflow

1. Soldering of the SMD LEDs should conform to the soldering condition in the individual specifications.
2. SMD LEDs are designed for Reflow Soldering.
3. In the reflow soldering, too high temperature and too large temperature gradient such as rapid heating/cooling may cause electrical & optical failures and damages of the devices.
4. We cannot guarantee the LEDs after they have been assembled using the solder dipping method.
5. There is possibility that the brightness of LEDs is decreased, which is influenced by heat or ambient atmosphere during reflow. It is recommended to use the nitrogen reflow method.
6. After LEDs have been soldered, repairs should not be done. As repair is unavoidable, a double-head soldering iron should be used. It should be confirmed beforehand whether the characteristics of the LEDs will be damaged by repairing or not.
7. Reflow soldering should not be done more than two times.

### (1) Lead Solder

Classification Reflow Profile (JEDEC J-STD-020C)

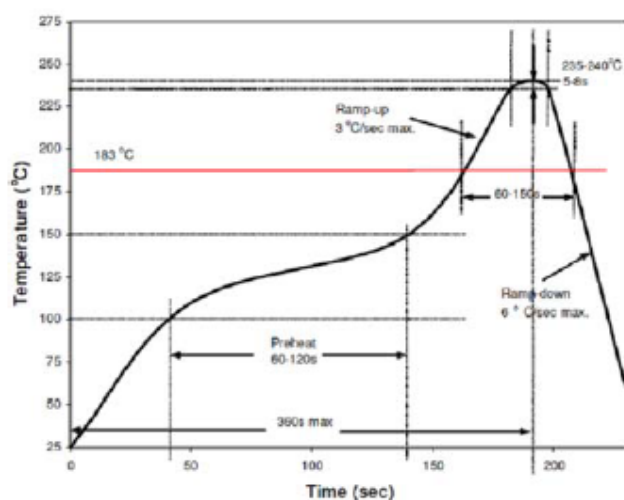

### (2) Lead-Free Solder

Classification Reflow Profile (JEDEC J-STD-020C)

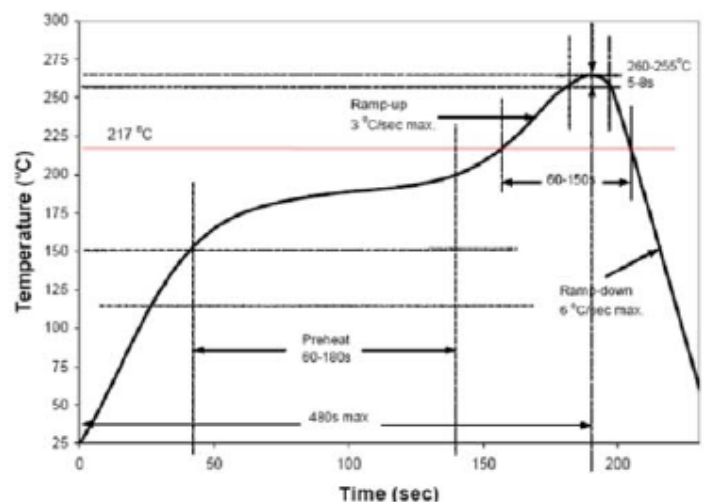

### (3) Manual Soldering Conditions

- a) Lead Solder: max. 300°C for max. 3sec., and only one time.
- b) Lead-Free Solder: max. 350°C for max. 3sec., and only one time.

# Dr. Licht GmbH

Vorlaenderweg 9 51588 Nuembrecht Germany  
Tele.: +49 2295 9035459 info@dr-licht.de

## Outline Dimensions [mm, Tolerance: $\pm 0.2$ mm]

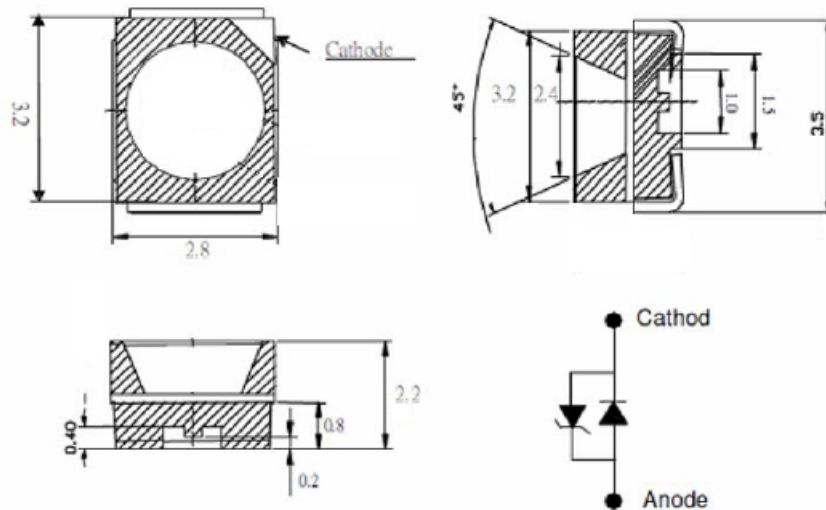

## Recommended Soldering Pattern

